



# Operating instructions

(Translation of the original operating instructions)

**LFE 101**

**LFE 201**

**LFE 301**

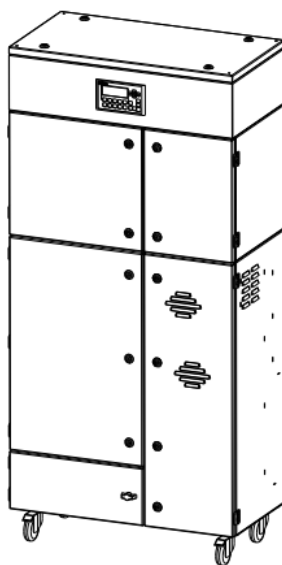

## Table of contents

<b>1. General</b>	<b>4</b>
<b>2. Description of the system elements</b>	<b>5</b>
2.1. Illustration of the system elements	5
2.2. Functionality of the system	6
2.3. Intended use	6
2.4. Residual risk	6
<b>3. Safety instructions</b>	<b>7</b>
3.1. Definition of the hazard symbols	7
3.2. General safety instructions	7
<b>4. Storage, transport and installation of the device</b>	<b>8</b>
<b>5. Commissioning</b>	<b>9</b>
5.1. Connecting the suction line and exhaust air line	9
5.2. Electrical connection	9
5.3. Coating of the filter cartridges with cartridge protection	10
5.4. Connecting the compressed air supply	10
5.4.1. Compressed air supply for the cleaning of the filter cartridges	10
<b>6. Operating the system</b>	<b>11</b>
6.1. Explanation of the operating elements	11
6.2. Connection of an external control	11
<b>7. Maintenance</b>	<b>12</b>
7.1. Reset to maintenance state	13
7.2. Cleaning the filter cartridges	13
7.3. Replacing the filter cartridges	14
7.4. Emptying the dust collecting tank	16
7.5. Draining the condensate	17
7.6. Coating of new filter cartridges with cartridge protection	18
7.7. Replacing the particle filter	19
7.8. Replacing the activated carbon / the activated carbon cassette	20
7.8.1. Replacing the activated carbon	20
7.8.2. Replacing the activated carbon cassette	22
7.9. Replacing the cooling air filters of the turbines	23
7.10. Replacing the filter mats for the air outlet grille	23
7.11. Cleaning/replacing the particle sensor	24
<b>8. Dismantling / Disposal</b>	<b>25</b>
<b>9. Diagnostics and troubleshooting</b>	<b>25</b>
<b>10. List of spare parts</b>	<b>27</b>
<b>11. Technical data</b>	<b>28</b>
<b>12. EC declaration of conformity</b>	<b>29</b>
<b>13. Training protocol</b>	<b>30</b>
<b>14. Maintenance intervals</b>	<b>31</b>

---

14.1. Usage-related maintenance	31
14.2. General maintenance	32
14.2.1. Visual inspection of the device	33
14.2.2. Visual inspection of the pipelines for dust deposits	33
14.2.3. Visual inspection of the pneumatic pipes	34
14.2.4. Functional test of the device	34
14.2.5. Electrical test of the electrical lines and earthing connections	35
14.2.6. Test of fixing of the mounted unit elements	35

## 1. General

Congratulations on purchasing the product from TEKA.

Our engineers ensure that our devices reflect the state of the art through continuous development. Nevertheless, misuse or misconduct can endanger your safety. Please observe the following for a successful use of the device:

	<p>Only authorised and instructed personnel can carry out transport, operation, maintenance and repair of the device. The operator must ensure that the operating personnel take note of these instructions.</p> <p>Please read these instructions before operating the device, and observe the safety precautions to avoid injury!</p> <p>Store this manual in a safe place! These instructions are to be regarded as a component of the product!</p> <p>Adhere to all product notes!</p> <p>Modifications or conversions that the operator carries out at the device without the consent of the manufacturer, can lead to new safety hazards or to the loss of warranty claims.</p> <p>Observe the manufacturer's instructions. Contact the manufacturer in case of any uncertainty: Tel: +49 2541-84841-0 E-mail: info@teka.eu</p>
---	---

## 2. Description of the system elements

### 2.1. Illustration of the system elements

Installation example:

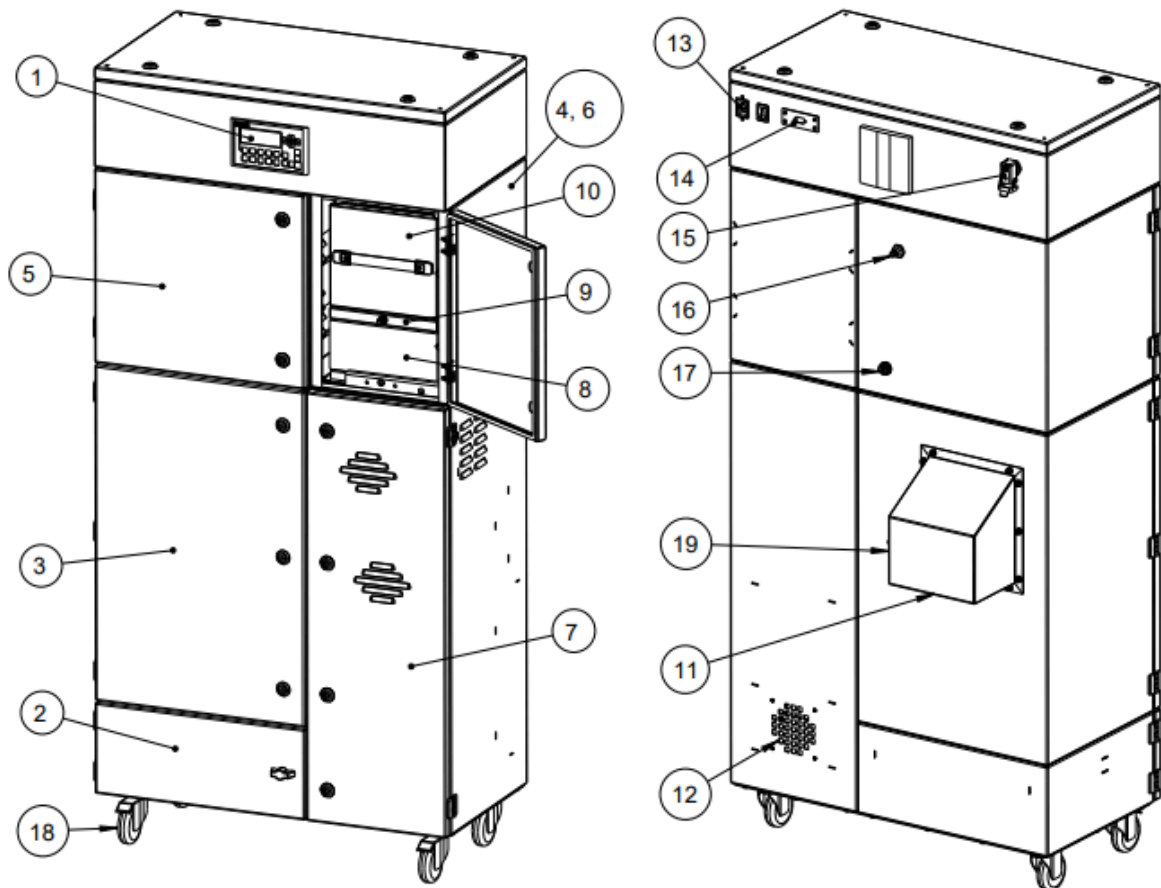

Z.Nr. 14261701

Pos.1	Operating panel of the control	Pos.11	Suction nozzle
Pos.2	Dust collecting housing	Pos.12	Exhaust grille
Pos.3	Filter housing	Pos.13	Connection for mains cable
Pos.4	Particle filter housing	Pos.14	Connection for external control unit
Pos.5	Cleaning housing	Pos.15	Industrial connector for the optional gate valve
Pos.6	Activated carbon housing	Pos.16	Connection for compressed air
Pos.7	Turbine housing	Pos.17	Drain valve for compressed air
Pos.8	Particle filter	Pos.18	Swivel castor
Pos.9	Intermediate frame	Pos.19	Connection for Metering device
Pos.10	Activated carbon cassette		

## 2.2. Functionality of the system

The filter unit serves to suck off and filter polluted air (according to the intended use). The air is purified on the surface of the filter cartridge in the filter section of the unit. The separated dust is collected in a dust collecting tank. The activated carbon filter absorbs gases and unpleasant odours. The subsequent particle filter cleans even fine smokes and dusts. An automatic filter monitoring indicates when a cleaning or a replacement of the filters is necessary. The purified air is led back into the working room via an exhaust air grille.

## 2.3. Intended use

The device is intended for commercial use. If the device is made publicly accessible, it must never be operated unsupervised by authorized personnel, authorized by the operator.

The intended use of the filter unit is the application combined with laser devices and especially the extraction and filtration of dusts, fumes and gases.

	<b>WARNING</b>
	<p><b>Improper use can damage parts and be a danger to life and limb!</b> The device must not be used for the extraction of oil-laden welding fume, explosive dust and gases, hybrid mixtures, glowing or burning substances, gases, water, etc. The device must not be operated in explosive zones.</p> <hr/> <p><b>Dangers arising from fire.</b> If the sucked medium is combustible fume or dust, the operator must determine beforehand which fire protection measures are to be taken.</p>

## 2.4. Residual risk

	<b>CAUTION</b>
	<p><b>Danger due to possible hazardous materials in the exhaust air flow.</b> Because the unit does not monitor the quality of the air in the exhaust air flow, we recommend that you always guide the exhaust air flow exiting our unit to areas (e.g. to the outside into the open air) in which there is no danger to any living being. To do this, it is necessary to fit a suitable exhaust air line at the filter unit.</p>

## 3. Safety instructions

### 3.1. Definition of the hazard symbols

The device is constructed according to the state of the art and the recognised safety regulations. Nevertheless, during use threats to life and limb of the user or other persons may arise. The impairment of the machine or other property are also possible. In these instructions we warn by using corresponding indications.

	<b>WARNING</b>
	<p><b>WARNING</b> These instructions are made in case of risks that can lead to <u>injury or death</u>.</p>

	<b>CAUTION</b>
	<p><b>CAUTION</b> These instructions are made in case of risks that can lead to <u>injury</u>.</p>

	<b>NOTICE</b>
	<p><b>NOTICE</b> These instructions are made in case of risks that can lead to <u>material damages</u>.</p>

	Information notes are no hazard warnings; they call attention to useful information.
---	--

### 3.2. General safety instructions

	<b>WARNING</b>
	<p><b>Dangers arising from improper use / unauthorised operations.</b> The operator must ensure that their authorised personnel are familiar with all the safety indications in this manual in advance. The operator is responsible for ensuring that all work is carried out by authorised and qualified personnel. We therefore recommend using the training protocol on the last page for that purpose (see chapter "Training protocol"). Laymen are allowed to operate the device after having received the necessary instructions. But they are not allowed to carry out any installation, repair or maintenance work.</p> <hr/> <p><b>Dangers arising from fire.</b> In case of fire, if possible, switch the unit immediately off or disconnect it from the power supply. Fire extinguishing measures which the operator is obliged to determine beforehand must be initiated immediately. The device is additionally equipped with a particle sensor, which can detect an increase of the particles (eg due to fire, filter break, ...) within the device. The particle sensor thus provides a monitoring of the particulate matter, but does not provide 100% protection for the detection of a fire. When the particle sensor is triggered, the device switches off.</p>

	<b>WARNING</b>
<p><b>Dangers arising from electricity.</b> The operator must ensure that electrical plants and equipment are only built, modified and maintained by a qualified electrician or under the direction and supervision of a qualified electrician. Do not work on components if you are not sure that these are disconnected. If necessary, disconnect the device from the electric power supply and secure it against unauthorized restarting.</p>	

## 4. Storage, transport and installation of the device

	<b>WARNING</b>
<p><b>Risk of injury from tilting or unmounted components when stored or transported.</b> The device must be secured against tilting and slipping when it is stored or transported. Do not stand under or next to the floating load. Lift trucks, forklift trucks and transport cranes must have a sufficient minimum load bearing capacity. Pay attention to uneven grounds during the transport. Avoid jerky pushing.</p> <hr/> <p><b>Dangers arising from tilting or functional impairments at its destination.</b> The unit may only be set up on a suitable surface. The surface must be vibration-free and horizontal. The operator must check the bearing capacity of the surface. As soon as the unit has reached its intended destination, the brakes of the castors must be activated.</p>	

	<b>NOTICE</b>
<p><b>Damage or functional impairment of the unit due to climatic influences.</b> The unit must be stored in a dry place and protected against moisture during transport. As a matter of principle, the filter unit is not designed to be installed outside.</p>	



## 5. Commissioning

	<b>WARNING</b>
<p><b>Dangers arising from a defective condition of the unit.</b> Make sure that the measures described in this chapter are completed before the commissioning of the unit. All doors of the unit must be closed and all necessary connections must be attached before turning the unit on. Do not operate the unit if any components are defective, missing or damaged. Check the orderly condition of the unit before switching it on. The unit must not be operated without a filter element.</p>	

	<b>NOTICE</b>
<p><b>Damaged supply lines.</b> Make sure that the supply lines are protected against damage by forklift trucks and similar events. Protect all supply lines from heat, moisture, oil and sharp edges.</p>	

### 5.1. Connecting the suction line and exhaust air line

For extracting the contaminated air, a suction line must be connected to the suction nozzle (see chapter 2.1).

If the air shall be directly sucked off by an upstream machine, the suction line must be connected to the capture opening of the upstream machine.

The purified air is led back into the working environment via the exhaust air grille (see chapter 2.1) (recirculation mode). If it is desired to lead the purified air out of the working environment, an exhaust air pipe must be attached at the discharge grille.

### 5.2. Electrical connection

	<b>CAUTION</b>
<p><b>Health hazard arising from unintentional cleaning processes.</b> Switch on the control only if the unit is in operational condition.</p>	

	<b>NOTICE</b>
<p><b>Electric malfunction possible in cause of an incorrect power supply.</b> Pay attention to the admissible supply voltage. Please observe the specifications on the type plate.</p>	

- Connect the mains cable (see chapter 2.1) to the power supply.

## 5.3. Coating of the filter cartridges with cartridge protection

For a longer service life of the filter cartridges, the new filter cartridges can be coated with a cartridge protection. However, this is not necessary when using nano filter cartridges.



Please read and refer to "Coating of new filter cartridges with cartridge protection" in the chapter "Maintenance". There you can also find a description of the operating method of the cartridge protection.

## 5.4. Connecting the compressed air supply



### NOTICE

**The compressed air must be dry and oil-free.**

According to ISO 8573-1:2010 the compressed air quality must at least meet: [7:4:4]

- Partikle size:  $<40\mu\text{m}$
- Pressure dew point:  $\leq +3^{\circ}\text{C}$
- Oil content:  $\leq 5\text{mg}/\text{m}^3$

### 5.4.1. Compressed air supply for the cleaning of the filter cartridges

The filter cartridges of the system are automatically cleaned. Cleaning is carried out pneumatically via a built-in compressed air tank.



Without compressed air supply the filter cartridges will become dirty very quickly.

- The external compressed air supply must be assured with an approved compressed air hose. For the connection to the device, the compressed air hose must be equipped with a quick coupling for an insert sleeve DN 7.2.

**NOTICE** The compressed air must be dry and oil-free.

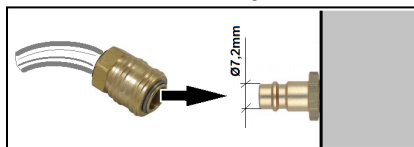

- The operating pressure of the compressed air supply must be a minimum of 3 bars and maximum of 4 bars.



**NOTICE** In case of the pressure being too low, the compressed air tank does not reach quickly enough the operating pressure for the following cleaning. There is a risk of material damage when the pressure is too high.

- Connect the compressed air hose to the insert sleeve (see chapter 2.1).

## 6. Operating the system

### 6.1. Explanation of the operating elements

 Control functions, setting options for programs, menu navigation, error messages, etc. are described in the enclosed operating manual of the unit control. There is also an explanation of the elements of the control panel.

Operating elements for the device control		
Representation	Designation	Description / function
	ON-OFF-switch	By means of this switch, the device is switched on and off.  When the device is switched off, it is <u>not</u> disconnected from the power supply.

### 6.2. Connection of an external control

There is the possibility to control the unit from extern. For this purpose, a connection is provided on the unit (see chapter 2.1).

Connection plug type:	<b>Industrial connector</b>
Number of pins:	<b>10</b>

Pin-Nr.	Designation	Explanation
<b>1, 2</b>	Start contact	In order to switch on the filter unit, a contact has to be connected between pin 1 and pin 2. The unit is switched out when the contact is opened.  When the follow-up time is activated, the unit switches off after the preset period of time.
<b>3, 4</b>	External message "Fault"	Pin serves for the evaluation of an fault indication. (NO: normaly open)
<b>5, 6</b>	External message "Operation"	Pin serves for the evaluation of the operational control. (NO: normaly open)
<b>PE</b>	Protective earthing	Potential equalisation

## 7. Maintenance

In accordance with national regulations, the operator is obliged to carry out repeat and functional tests. Unless otherwise specified by national regulations, we recommend regular visual inspections and functional tests of the device as described in the chapter “Maintenance intervals”.



You find the chapter “Maintenance intervals” at the end of the document. The general maintenance (visual inspection, etc.) is also explained there.

In the chapter “Maintenance intervals” there is information on the maintenance intervals of the filter elements. But these are only recommendations. Depending on the application (multi-shift operation, dust generation, ...) it may be necessary for the operator to change the maintenance intervals.

In this chapter the maintenance work which is caused by wear caused during operation is described.



### WARNING

**Work on the open system entails the risk of electrical shock or accidental restart the system. Both pose a danger to life and limb.**

When cleaning and servicing equipment during the replacement of parts or when changing to another function, set the device to maintenance condition first (see chapter “Reset to maintenance state”).

A recommissioning of the device must only occur if it is ensured that the device is functionally equivalent to the original state.



### CAUTION

**Hazards to the respiratory tracts are possible.**

All maintenance work must only be carried out in well-ventilated rooms and while wearing an appropriate respiratory mask! We recommend: respiratory protection half mask DIN EN 141/143 protection level P3. For all maintenance work ensure a cautious handling of filter elements and components in order to avoid whirling up dust.



The operator is obliged to store and dispose of the collected dust in accordance with national or regional regulations. For all maintenance or cleaning work please refer to the applying environmental regulations. Pollutants and filter elements must be disposed of or stored according to the regulations as well. If you have any doubts, we recommend contacting a disposal contractor in your area.

## 7.1. Reset to maintenance state

- Switch off the unit. Unplug the mains plug. Secure the unit against unauthorized restarting during maintenance.
- Disconnect the compressed air hose of the external compressed air supply from the insert sleeve (see chapter 2.1).
- Empty the compressed air tank by opening the drain valve (see chapter 2.1) with a suitable screwdriver. Minor quantities of condensation water can leak out when opening the drain valve. Close the drain valve when the compressed air tank is entirely empty.  
**CAUTION** When opening the drain valve a jet of compressed air can occur.
- After completion of all maintenance work the unit can be reconnected to the power supply and the external compressed air supply.

## 7.2. Cleaning the filter cartridges

	<b>CAUTION</b>
<p><b>A sudden jet of compressed air and huge amounts of whirled up dust are possible due to an automatic cleaning with an opened service door.</b></p> <p>During the operation of the device, the service door of the filter housing must not be opened. The same applies to the ready to operate condition (standby) as there is also the possibility of an automatic cleaning (subsequent cleaning).</p>	

The filter cartridges are reusable filters and can be cleaned. The cleaning of the filter cartridges is automatically carried out.

The degree of pollution of the filter cartridges is electronically monitored. In order to assure the required extraction capacity of the device, the cleaning of the filter cartridges starts automatically when a preset differential pressure value is reached. If the preset differential pressure value is not undercut after the cleaning of the filter cartridges, another cleaning starts. The filter unit remains in operation during the automatic cleaning. The compressed air blast is produced in opposite direction to the intake. The cleaned dust falls downwards in the dust collecting tank.





Depending on the setting of the control unit there can be automatic postcleanings of the filter cartridges even when the unit is switched off.

When the maximal admissible differential pressure value is reached, the device triggers an alarm (see chapter "description of the control elements"). If despite of the automatic cleaning of the filter cartridge the alarm value is not undercut anymore, the filter cartridge must be replaced. (see chapter: "Replacing the filter cartridges").

The differential pressure values in the control unit that initiate a cleaning or a filter alarm are preset values adapted to the filter unit. Please find detailed information concerning the functioning in the enclosed operating instructions of the control unit.

## 7.3. Replacing the filter cartridges

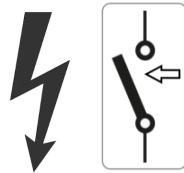
Replacing the filter cartridges becomes necessary when the filter cartridges are saturated with dirt in a manner that despite of the cleaning the filter alarm is triggered again at very short intervals or permanently. (The filter alarm is described in chapter "Cleaning the filter cartridges".)

	<b>CAUTION</b>
	<p><b>Whirling up dust is possible due to the polluted filter cartridges. Danger of unintentional automatic cleaning with the unit switched off.</b></p> <p>The filter cartridges must be cleaned before being replaced. This is done by carrying out 3 manual cleanings via the unit control (see separate operating instructions). The filter unit must be switched off beforehand but without disconnecting the unit from the power supply. After the cleaning, disconnect the filter unit from the power supply and secure it against being switched on again. After cleaning the filter cartridges wait about 5 minutes before opening the service door of the filter housing.</p> <div style="display: flex; justify-content: space-around; align-items: center;"> <div style="text-align: center;">   <b>OFF</b> </div> <div style="text-align: center;">  </div> <div style="text-align: center;">  </div> <div style="text-align: center;">   <b>5 min</b> </div> </div>

	<p>We recommend using a disposable protective suit when changing the filter cartridges.</p>
	<p>For a longer service life of the filter cartridges the new filter cartridges can be coated with cartridge protection. However, this is not necessary when using nano filter cartridges. If you wish to coat the new filter cartridges nevertheless, please refer to the indications in the chapter "Coating of new filter cartridges with cartridge protection". There you can also find a description of the operating method of a cartridge protection.</p>

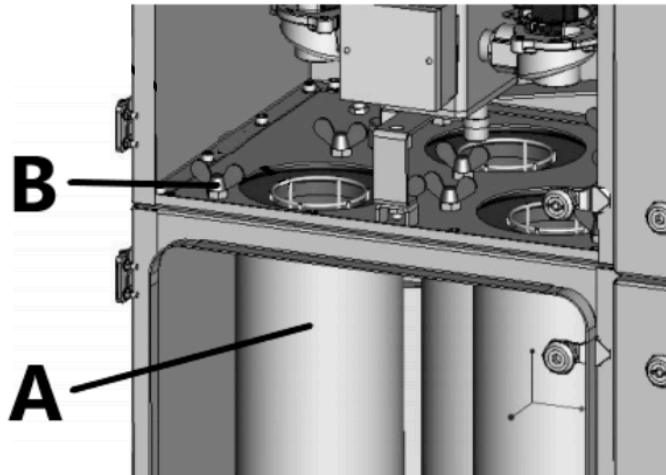

- Before changing the filter cartridges hold ready an appropriate container (e.g. PE bag) for disposal.

**CAUTION** The polluted filter cartridges must be packed into an appropriate container (e.g. PE bag). PE bags are optionally available (see list of spare parts)! We recommend having disposal bags in stock.

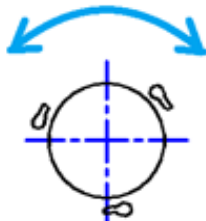

- Open the service door of the filter cartridges. Also open the service door of the cleaning housing. This is only possible by means of a special electrical spanner.
- Slip the disposal bag from bottom to top over the filter cartridge (A).
- Unfasten the 3 thumb screws (B) of the filter cartridge by turning them clockwise.
- Grab the filter cartridge and turn it a little clockwise to disconnect it from the screw fastening. Therefore do not touch the filter cartridge directly with your hands, but grab it from the outside through the bag.



- Carefully close the disposal bag (e.g. with a cable fastener) and store or dispose of it together with the polluted filter cartridge in an appropriate container according to the regulations.
- Insert the new filter cartridge into the screw fastening and turn it anticlockwise to the hilt.  
**NOTICE** Only use TEKA spare filters. Otherwise the proper functioning of the unit is not guaranteed.
- Hand-tight screw the 3 thumb screws.
- Carry out this procedure for all filter cartridges.
- Close the service door.

## 7.4. Emptying the dust collecting tank

The dust collection container must be cleaned after a certain number of operating hours. This range depends on the amount of dust. The dust collecting tank may only be filled up to a maximum of 25%. The filling level has to be proofed at least once a week.

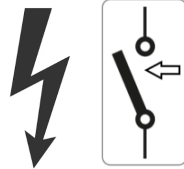
	<b>CAUTION</b>	<b>Whirling up dust is possible due to the polluted filter cartridges! Danger of unintentional automatic cleaning with the unit switched off.</b>				
	<p>The filter cartridges must be cleaned before emptying the dust collecting tank. This is done by carrying out 3 manual cleanings via the unit control (see separate operating instructions). The filter unit must be switched off beforehand but without disconnecting the unit from the power supply. After the cleaning, disconnect the filter unit from the power supply and secure it against being switched on again. After cleaning the filter cartridges wait about 5 minutes before opening the service door.</p>					

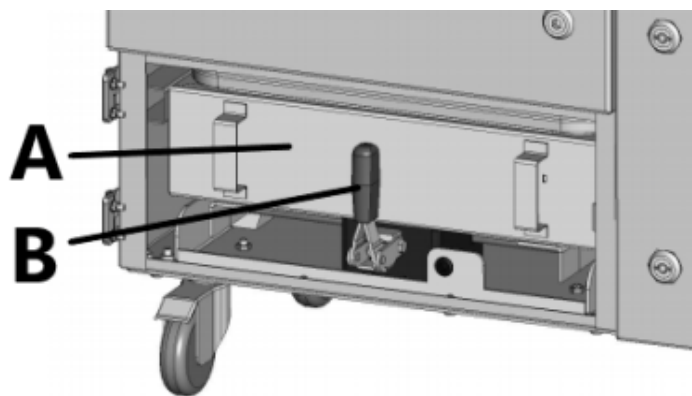

- Open the service door of the dust collecting housing (see chapter 2.1).
- Release the clamping lever (B) of the dust collecting tank (A).
- Carefully pull the dust collecting tank out of the housing.
- Empty the dust collecting tank into an appropriate, closable container or bag. Dispose of or store the dust according to the regulations.
- Push the dust collecting tank back into the dust collecting housing.
- Manipulate the clamping lever so that the dust collection container is pressed tightly against the above housing.
- Close the service door.



## 7.5. Draining the condensate

Operation with compressed air can result in condensation water being gradually deposited in the compressed air tank. The condensed water must be emptied regularly. The maintenance interval depends heavily on the quality of the compressed air and cannot, therefore, be determined in advance.

	<b>CAUTION</b>
<b>When opening the drain valve a blast of compressed air is possible.</b> Open the drain valve slowly.	

- Empty the compressed air tank by opening the drain valve (see chapter 2.1) with a suitable screwdriver. Let the escaping condensate flow into a suitable container.





- Close the drain valve.

## 7.6. Coating of new filter cartridges with cartridge protection

Before the first commissioning new filter cartridges can be coated with cartridge protection. The cartridge protection assists against a "caking" of extracted particles on the filter surface and thus prolongs the life of the new filter cartridge.

Unlike with other maintenance work, this step must be carried out with the system switched on and operating. This is necessary to allow the cartridge protection to disperse on the surface of the filter cartridges through suction.

	<b>CAUTION</b>	
	<p><b>On contact the cartridge protection can be hazardous to the respiratory tract and cause skin irritation or eye irritation.</b> Observe the listed manufacturer instructions provided:</p> <p><i>Handling:</i> Avoid the formation of dust!  <i>Storage:</i> Seal the container tightly before storage!  <i>Respiratory protect:</i> Dust mask without protection level!  <i>Hand protection:</i> Protective gloves in cloth, rubber or leather!  <i>Eye protection:</i> Safety glasses with side shields!  <i>Body protection:</i> Anti-static work shoes!</p>	

	<b>CAUTION</b>
	<p><b>During operation of the device an automatic cleaning can take place. This involves the risk of a sudden jet of high-pressure air and excessive dust formation at the point of entry of the cartridge protection.</b> At first make sure that there is no compressed air in the compressed air tank. Please refer to the chapter "Reset to factory settings". Before switching the device back on, disconnect the compressed air hose from the device.</p>

- Provide sufficient cartridge protection. We recommend using **10 grams** for each **square metre** of the **filter surface**. The cartridge protection is available at TEKA (see list of spare parts).
- Choose the capture point in the suction pipe that is the closest to the filter cartridges. E.g. an inspection flap can be used as a capture point.
- Switch the device on.
- Let the cartridge protection bit by bit be sucked in via the capture point.

## 7.7. Replacing the particle filter

Replacing the particle filter is necessary when the device control signals the corresponding error. (see chapter "Description of the control elements").



### CAUTION

**Whirling up dust is possible.**

The particle filter is a disposable filter element. Do not try to clean the filter element.



The particle filter has the function of a police filter. This means that the filter is located behind the other filter elements according to the air flow direction. The police filter ensures that only clean air from the filter system flows back into the environment, even if one of the other filter elements is defective. The filter unit switches off when the police filter is saturated and can not be operated as long as the error message persists.

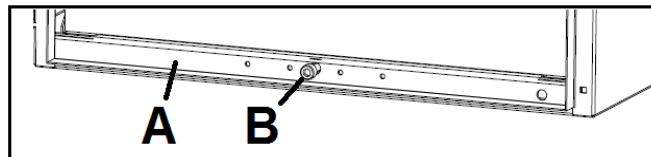

- Open the service door of the particle filter housing (see chapter 2.1).
- Lower the lifting device (A) by turning the clamping screw (B).
- Carefully pull the entire filter pack, incl. the particle filter (see chapter 2.1) out of the housing. Before doing so the projecting measuring hose has to be separated from the intermediate frame.
- Replace the particle filter.  
**NOTICE** Only use TEKA spare filters. Otherwise the proper functioning of the unit is not guaranteed.
- Push the filter pack back into the filter housing as far as it will go. Make sure that the filter elements are inserted in the correct order. Then reconnect the measuring hose at the intermediate frame.  
**NOTICE** The seals of the particle filter, the activated carbon cassette and the intermediate frame must always be on the top.
- Elevate the lifting device by turning the clamping screw so that the upper filter element is pressed tightly against the above housing.
- Close the service door.



## 7.8. Replacing the activated carbon / the activated carbon cassette

The activated carbon absorbs gases and unpleasant odours. The activated carbon has to be replaced as soon as gases appear on the clean air side.

Therefore, replace the activated carbon in the activated carbon cassette. Alternatively, you can replace the entire activated carbon cassette. Different spare parts are required for these two options (see list of spare parts).

 The saturation degree of the activated carbon is not monitored.

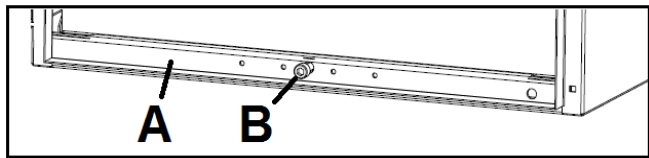
### 7.8.1. Replacing the activated carbon

<ul style="list-style-type: none"> <li>• Open the service door of the activated carbon housing (see chapter 2.1).</li> <li>• Lower the lifting device (A) by turning the clamping screw (B).</li> <li>• Carefully pull the entire filter pack, incl. the activated carbon cassette (see chapter 2.1), out of the housing. Before doing so the projecting measuring hose has to be separated from the intermediate frame.</li> </ul>	
<ul style="list-style-type: none"> <li>• Remove the cover of the activated carbon cassette. To do this, it is necessary to undo the screws. <i>(The activated carbon cassette shown in the illustration may possibly be of a different size to the one installed in your filter unit. However, the principle is identical.)</i></li> <li>• Remove the top filter fleece mat.</li> </ul>	
<ul style="list-style-type: none"> <li>• Carefully empty the activated carbon. The used activated carbon must be emptied into an appropriate container and disposed of.</li> </ul>	

<ul style="list-style-type: none"> <li>Remove the bottom filter fleece mat.</li> <li>Insert the new filter fleece mat here. This must completely cover the holes in the grille at the base.</li> </ul>	
<ul style="list-style-type: none"> <li>The new activated carbon must be carefully filled into the activated carbon cassette. Gradually fill with a number of smaller quantities of activated carbon, spreading it out evenly and gently pressing down on it as you do so.</li> </ul> <p><b>NOTICE</b> Only use TEKA spare filters. Otherwise the proper functioning of the unit is not guaranteed.</p>	
<ul style="list-style-type: none"> <li>The cassette must be filled with activated carbon up to the height of the support surface (A) and levelled off.</li> <li>Place the new top filter fleece mat over the activated carbon. It may be necessary to cut the filter fleece mat to the right size. The size must correspond to the dimensions of the cover.</li> </ul>	
<ul style="list-style-type: none"> <li>Screw the cover back on again. When you do this, the cover must press the top filter fleece mat against the support surface of the activated carbon cassette all the way round.</li> </ul>	

- Push the filter pack back into the filter housing. Make sure that the filter elements are inserted in the correct order. Then reconnect the measuring hose at the intermediate frame.

**NOTICE** The seals of the particle filter, the activated carbon cassette and the intermediate frame must always be on the top.

- Elevate the lifting device by turning the clamping screw so that the entire filter pack is pressed tightly against the above housing.
- Close the service door.

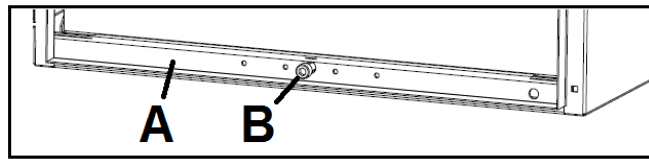

## 7.8.2. Replacing the activated carbon cassette

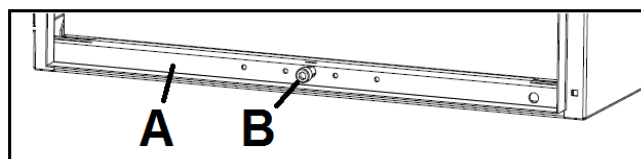

- Open the service door of the activated carbon housing (see chapter 2.1).
- Lower the lifting device (A) by turning the clamping screw (B).
- Carefully pull the entire filter pack, incl. the activated carbon cassette (see chapter 2.1), out of the housing. Before doing so the projecting measuring hose has to be separated from the intermediate frame.
- Replace the activated carbon cassette.  
**NOTICE** Only use TEKA spare filters. Otherwise the proper functioning of the unit is not guaranteed.
- Push the filter pack back into the filter housing. Make sure that the filter elements are inserted in the correct order. Then reconnect the measuring hose at the intermediate frame.  
**NOTICE** The seals of the particle filter, the activated carbon cassette and the intermediate frame must always be on the top.
- Elevate the lifting device by turning the clamping screw so that the entire filter pack is pressed tightly against the above housing.
- Close the service door.

## 7.9. Replacing the cooling air filters of the turbines

The cooling air filters of the turbines must be checked regularly for pollution and they must be replaced when necessary (see list of spare parts).

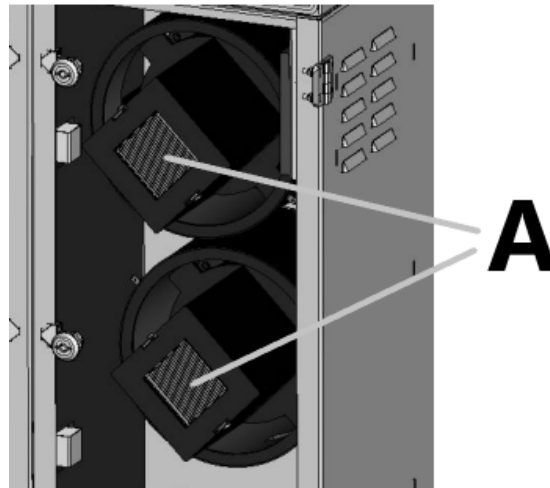

- Open the service door of the turbine housing. This is only possible by means of a special electrical spanner.
- Check the cooling air filters (A) for pollution. Replace them when necessary.
- Close the service door.

## 7.10. Replacing the filter mats for the air outlet grille

The filter mat is located in the ventilation grille of the control cabinet. The filter mat must be checked regularly and changed if necessary. This check depends on the degree of contamination. We recommend to stock with filter mats early on (see spare parts list).

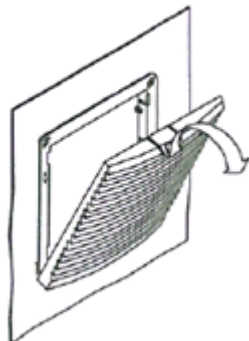

## 7.11. Cleaning/replacing the particle sensor



This section is only relevant, if the controller reports a "particle sensor" error message which persists after being acknowledged even though clearly no smoke is present. In such cases, it is probable that the particle sensor is too highly contaminated or faulty.

- The particle sensor is located inside the particle filter housing (see section 2.1).
- Remove the detector head from the assembly base. To do this, turn the detector head anticlockwise slightly.

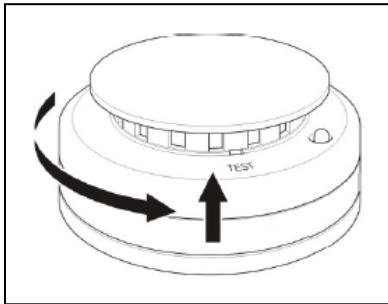

- Remove the cover. To do this insert a screwdriver and lift the cover. It is then necessary to pull the black cover off the smokebox.

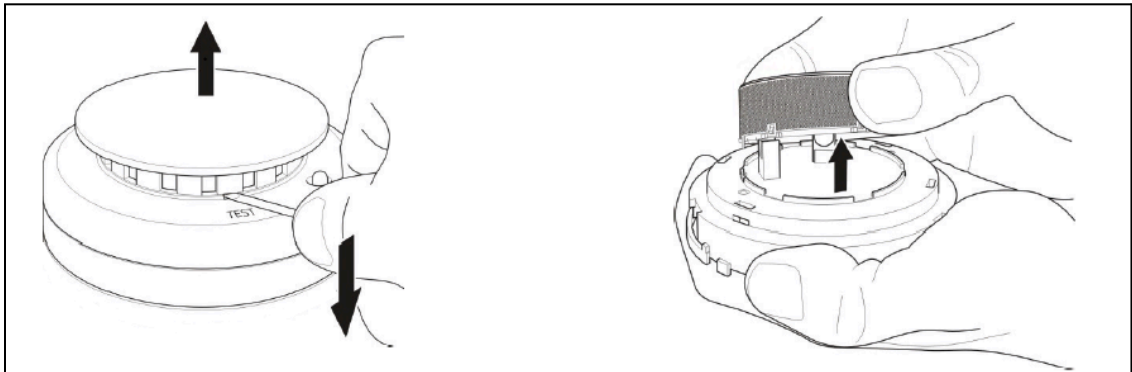

- Use compressed air to expel dust from the smokebox.  
**NOTICE** Do not use a dust cloth.
- Mount the covers. Replace the detector head on the assembly base.

If the controller now still reports a "particle sensor" error message then the detector head must be replaced.

**NOTICE** Replacement parts are available from TEKA, see the spare parts list. In this case, it is not necessary to replace the assembly base which is screwed to the unit.



## 8. Dismantling / Disposal

Only authorised personnel may disassemble the machine.

	<b>WARNING</b>
	<p><b>Dangers arising from electricity.</b> Before the dismantling of the machine it has to be disconnected from the power supply and all supply lines.</p>

	<b>CAUTION</b>
	<p><b>Whirling up dust is possible due to the deposited dust.</b> During all work a suitable respiratory protection and protective clothing have to be worn.</p>

	The operator is obliged to store and dispose of the collected dust in accordance with national or regional regulations.
---	---

## 9. Diagnostics and troubleshooting

A list of possible system errors is provided in the table.

	Error messages of the control unit are described in the enclosed operating manual of the control unit.
---	--

A recommissioning of the device must only occur if it is ensured that the system is functionally equivalent to the original state. Repairs may only be carried out by TEKA personnel or, after consultation with TEKA GmbH, by the personnel authorised by the operator.

Adhere to the instructions in the chapter "Safety instructions" and "Maintenance" when carrying out any repairs. If in doubt, contact our TEKA service department:

Tel: +49 2541-84841-0  
E-mail: info@teka.eu

Fault	Cause	Removal
System does not start.	Plug power supply is missing or incorrectly inserted.	Plug connector check power supply / plug in correctly.
	No power at outlet.	Check the mains, remove error if possible.
Dust at the dust collecting tank.	There is too much dust in the dust collection container.	Empty the dust collecting tank.
	The clamping lever has not been lift up.	Lift up the clamping lever.

Fault	Cause	Removal
	The seal of the dust collecting tank is damaged.	The seal must be replaced.
	The compressed air for the dedusting is set too high.	Reduce the compressed air.
Dust at the service door of the filter housing.	The door is not correctly closed.	Close the door.
	The seal between the service door and filter housing is damaged.	The seal must be replaced.
	The compressed air for the dedusting is set too high.	Reduce the compressed air.
	Escape of dust at the hinge.	The hinge must be reoriented or replaced.
Suction power too low (smoke hardly extracted).	Filter element is saturated.	Replace the filter package, dispose of old filter properly!
	Filter elements are saturated because no compressed air is connected.	Connect compressed air.
	Damage at the extraction elements.	Replace the extraction elements.
	Suction line contracted.	Check and fix.
	Exhaust line contracted.	Check and fix.
	Maybe throttle valves are used in the suction line.	Adjust throttle valves.

## 10. List of spare parts

Filter element	Article no.
Filter cartridge, Type "easy clean nano", 2,7m <sup>2</sup> (Ø145 x 600 mm) ( 3 pieces of these filter elements are required for the device)	6160600302708
Particle filter "H13" (337 x 230 x 100)	100350004
Activated carbon cassette, 7,5 kg activated carbon (337 x 230 x 212) <b>or:</b> 7,5 kg activated carbon, including filter fleece mats	97059 100197310
Cooling air filter for turbine (62x62x48)	100350008
Filter mats for the air outlet grille (10 pieces)	5020007079
Disposal elements	Article no.
PE-bag for the disposal of filter cartridges (6 pieces)	800000241
Cartridge protection	Article no.
"NANNOX P50" for filter cartridges, 400g (in a bucket)	68130000400
"NANNOX P50" for filter cartridges, 100g (in a bucket)	68130000100
Other parts	Article no.
Particle sensor (detector head)	999204

## 11. Technical data

Version		LFE 101	LFE 201	LFE 301	LFE 301
Supply voltage	V	115 / 230	230	115 / 230	230
Frequency	Hz	50 / 60	50 / 60	50 / 60	50 / 60
Type of current	Ph	1	1	1	1
Engine power	kW	1x 0,6	1x 1,2	2x 0,6	2x 1,2
Air flow volume max.	m³/h	280	250	400	500
Negative pressure max.	Pa	6300 / 7500	11000	6300 / 7500	11000
Protection class		IP54			
ISO class		F			
Extraction performance	%	>99			
Width	mm	751			
Depth	mm	400			
Height	mm	1590			
Weight	kg	ca. 168			
Sound pressure level	dB(A)	68			
Allowed ambient temperature	°C	+5 to +35 (during operations) -10 to +40 (during transport and storage)			
Max. temperature of polluted air at the capture point	°C	+50			
Allowed max. humidity	%	70			
Compressed air supply		dry / oil-free			
Necessary external pressure	bar	see chapter "Connecting the compressed air supply"			

## 12. EC declaration of conformity

*according to the Machinery Directive 2006/42/EG, Annex II, 1 A*

TEKA Absaug- und Entsorgungstechnologie GmbH

Millenkamp 9, D-48653 Coesfeld

Tel.: +49 2541-84841-0

E-Mail: [info@teka.eu](mailto:info@teka.eu)

Internet: [www.teka.eu](http://www.teka.eu)

Designation of the device: LFE 101 / LFE 201 / LFE 301

We hereby declare under our sole responsibility that the product mentioned above, from the serial number A22600010011001 resp. P57300010011001 on, conforms to the following directives:

**Machinery directive:** 2006/42/EC

**Electromagnetic compatibility directive:** 2014/30/EU

**Pressure equipment directive:** 2014/68/EU

**RoHS directive:** 2011/65/EU

This declaration will become void if the device is exposed to modifications that are not approved by the manufacturer in written form.

Authorized representative for the technical documentation:

TEKA Absaug- und Entsorgungstechnologie GmbH, Millenkamp 9, D-48653 Coesfeld

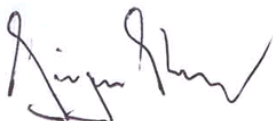

*(Jürgen Kemper, managing director)*

Coesfeld, 3rd January 2023



## 13. Training protocol

Designation of the device: LFE 101 / LFE 201 / LFE 301

*(This form can be used by the operator to document the training of the employees. Training should be performed by authorized personnel only. Refer to the instructions in Chapter "Safety Instructions")*

By his signature, the employee confirms that he has been instructed regarding the following items:

Instruction	completed
Description of the device	
Operation and application of the device	
Explanation of the safety instructions	
Behavior in case of fire	
Explanation of the operation elements	
Change and dedusting of the filter elements	
Emptying of the dust collecting tank	
Appropriate disposal	
Maintenance works / Maintenance intervals	

Name of the employee (legible)	Signature

Introduction through (legible):	
Signature:	

## 14. Maintenance intervals

### 14.1. Usage-related maintenance

The described maintenances become necessary through the demands of the system operations. The maintenance intervals are recommendations. Depending on the application (multi-shift operation, dust generation, ...) it may make sense for the operator to change the intervals of maintenance, replacing and cleaning.

Maintenance work must always be documented by means of a protocol.

The approach of the maintenance measures is described in chapter "Maintenance".

Maintenance work	Chapter	Maintenance interval	
		recommended by TEKA	determined by the operator
Cleaning the filter cartridges	7.2	The cleaning of the filter cartridges is automatically carried out by the filter unit and thus is not subject to a maintenance interval.	
Replacing the filter cartridges	7.3	The saturation of the filter cartridges is automatically monitored by the filter unit and thus is not subject to a maintenance interval. The filter unit triggers an alarm when a replacement of the filter cartridges is necessary.	
Replacing the particle filter	7.7	The saturation of the particle filter is automatically monitored by the filter unit and thus is not subject to a maintenance interval. The filter unit triggers an alarm when a replacement of the particle filter is necessary.	
Emptying the dust collecting tank (or check of fill level)	7.4	weekly	
Draining the condensate	7.5	monthly	
Replacing the activated carbon / the activated carbon cassette (or check the degree of pollution)	7.8	when odours occur	
Replacing the cooling air filters of the turbines	7.9	semi-annually	
Check / Replacing the filter mat for the air outlet grille	7.10	semi-annually	

## 14.2. General maintenance

The described maintenances are independent from the demands of the system operations.

The operator is obliged to carry out repeated inspections and functional tests according to national regulations. If not otherwise covered by national regulations, the described maintenance intervals must be respected.

Maintenance work must always be documented by means of a protocol.

Maintenance work	Chapter	Maintenance interval
<b>Visual</b> inspection of the device	<b>14.2.1</b>	weekly
<b>Visual</b> inspection of the pipelines for dust deposits	<b>14.2.2</b>	monthly
<b>Visual</b> inspection of the pneumatic pipes	<b>14.2.3</b>	monthly
<b>Functional</b> test of the device	<b>14.2.4</b>	monthly
<b>Electrical</b> test of the electrical lines and earthing connections	<b>14.2.5</b>	annually
Test of <b>fixing</b> of the mounted unit elements	<b>14.2.6</b>	annually



## 14.2.1. Visual inspection of the device

**Visual inspection:** Observation that there are no visible safety-related defects.

	<b>WARNING</b>
<b>Danger arising from the ready to operate condition of the device.</b> Follow the procedure as described in the chapter "Set to maintenance state".	

The following steps must be carried out in the course of the visual inspection:

- Check if all required pipeline elements, cable connections and hoses are connected to the filter unit
- Ensure that all parts are firmly connected.
- Check all connection points of the filter unit for escaping dust.
- Check all metal parts for corrosion or damages / changes of the coating.
- Check the inner filter area and the filter housing.
- Visual inspection of the control and operating elements as well as the outside running cables for damages.
- Check the dust collecting tank for tightness, check the sealing rubber of the tank.

## 14.2.2. Visual inspection of the pipelines for dust deposits

**Visual inspection:** Observation that there are no visible safety-related defects.

	<b>WARNING</b>
<b>Danger arising from the ready to operate condition of the device.</b> Follow the procedure as described in the chapter "Set to maintenance state".	

The following steps must be carried out in the course of the visual inspection:

- Open the inspection flaps of the pipeline and check the pipeline for dust deposits. Dust deposits must be eliminated.

## 14.2.3. Visual inspection of the pneumatic pipes

**Visual inspection:** Observation that there are no visible safety-related defects.

	<b>WARNING</b>
<b>Danger arising from the ready to operate condition of the device.</b> Follow the procedure as described in the chapter "Set to maintenance state".	

The following steps must be carried out in the course of the visual inspection:

- Open the service door of the cleaning housing .
- Carry out a visual inspection of the pneumatic parts.

## 14.2.4. Functional test of the device

	<b>NOTICE</b>
<b>Possible material damage due to faulty condition of the unit.</b> Carry out a visual inspection before the functional test of the device as described in the previous chapters. The work as described in the chapter "Commissioning" must be finished.	

The following steps must be carried out in the course of the functional test:

- Switch on the device.
- Pay attention to failures or error messages of the control unit. Also refer the separated operating manual of the control unit.
- Pay attention to extraneous noises or vibrations during the device's operation.
- Carry out a manual dedusting of the filter cartridges. Also refer to the separated operating manual of the control unit.
- Check if within one interval of the filter dedusting the number of dedusting shocks is equal to the number of filter cartridges (in each interval successively every filter cartridge becomes dedusted once).
- Check if dust is escaping from the unit during the dedusting cycle.
- A functional test should always be carried out with a connected / producing machine tool. Check if the collection of the fume or dust is sufficient. (Visual inspection).

## 14.2.5. Electrical test of the electrical lines and earthing connections

	<b>WARNING</b>
<b>Danger arising from electricity.</b> The operator is responsible for ensuring that all work on electric components is carried out by authorised and qualified personnel.	

The device is subject to regular electrical checks by the operator of the device, and are subject to national standards of the different countries.

The here recommended maintenance interval complies with the in Germany applying "Regulation 3 of the German Social Accident Insurance - Electrical plants and equipment" (formerly known as BGV-A3).

The check must only be carried out by a qualified electrician or a person trained in electrics using suitable measuring and test devices. The scope of testing and the methods must be in line with the respective national standard. All contacts in the control cabinet must be checked for tight fit, and must be readjusted if necessary.

## 14.2.6. Test of fixing of the mounted unit elements

The following steps must be carried out in the course of the inspection:

- Make sure that all elements that are connected at or with the unit are firmly fixed in place and have not come undone or loose. These also include all air-carrying lines, all extraction elements, bearing structures and frames.
- In the case of unit elements which are subject to vibrations and/or movements, the operator may need to define a shorter maintenance interval.